





Gavita Pro 270^e LEP EU

1. Introduction

Thank you for purchasing the Gavita Pro 270^e LEP EU. Please read and understand this manual completely before using the product. Only use the product as specified in this manual.

1.1. Used symbols

-  **Warning!** A warning indicates severe damage to the user and/or product may occur when a procedure is not carried out as described.
-  **Caution!** A caution sign indicates problems may occur if a procedure is not carried out as described. It may also serve as a reminder to the user.
-  **Note:** A note gives additional information, e.g. for a procedure.

-  This symbol indicates that the parts of the fixture can reach very high temperatures (>85 °Celsius). Mind a cool down period before performing maintenance.

-  With this symbol Gavita declares that this product complies with legal European requirements.

-  This symbol indicates that any cracked protective shield should be replaced.

-  The symbol on the material, accessories or packaging indicates that this product may not be discarded as household waste. Dispose of the equipment through a recycling centre that handles electronics and electrical appliances within the EU and in other European countries which use separate collection systems for used electronics and electrical appliances. By disposing of the equipment in the proper way, you will be helping to prevent possible risks to the environment and public health, which might otherwise be caused by improper handling of the discarded equipment. Recycling of materials contributes to the conservation of natural resources. Therefore, please do not dispose of your old electronics and electrical appliances via household waste.

-  This symbol is an internationally recognized symbol used to designate recyclable materials.

2. Product description

The Gavita Pro 270^e LEP is a horticultural fixture and can also be used in any environment when a high quality, full continuous light source has advantages.

The Gavita Pro 270^e LEP is an e-series product. It can be remotely activated by a Gavita Master controller. The Master controller can automatically activate and deactivate fixtures during a 24 hour cycle. The Master controller also offers a temperature safety feature, deactivating connected fixtures when the temperature in a climate room becomes too high.

In this manual, the Gavita Pro 270^e LEP will be referred to as: “the fixture”.

3. Product information and specifications

3.1. General product information

Product name:	Gavita Pro 270 ^e LEP Grow EU			Gavita Pro 270 ^e LEP Sup EU		
Manufacturer:	Gavita Holland bv					
Version	Grow EU	Grow UK	Grow CH	Sup EU	Sup UK	Sup CH
EAN Code	8718403051377	8718403051667	8718403051681	8718403051360	8718403051650	8718403051674
Part number	18.50.34.23.10.02	18.50.34.24.11.02	18.50.34.23.12.02	18.50.34.23.10.01	18.50.34.24.11.01	18.50.34.23.12.01
Lamp	GRO 41-02			GRO 41-01		
Plug type (Depending on the order, only one of the plug types is included)	EU plug 230 V	UK plug 240 V	CH plug 230 V	EU plug 230 V	UK plug 240 V	CH plug 230 V

3.2. Technical specifications

Product weight	11 kg
Dimensions (L*W*H)	58*27*19 cm
Temperature case	80 °Celsius
Temperature ambient	0 ~ 35 °Celsius
Input voltage +/-10%	230 - 240 V AC
Input current	1.5 Amp typical (1,7 Amp max.)
Inrush current	≤ 30 Amps
Power factor	0.98
Total Harmonic Distortion	< 10%
Frequency	50 - 60 Hz
Certification	CE
Insulation	Class 1 - requires an earth connection
Power inlet	IEC C14
External control signal	Gavita Master controller analog protocol (<11,5V) - see manual EL controller
External dim connector	RJ14 connector build in (6P6C On/off only. Dimming is not supported by the Master controller)

3.3. Compatible products and accessories

	Product name	Gavita part number
Compatible controllers	Gavita Master Controller EL1 EU	60.55.00.23.10
	Gavita Master Controller EL2 EU	60.56.00.23.10
	Gavita Master Controller EL1 UK	60.55.00.24.11
	Gavita Master Controller EL2 UK	60.56.00.24.11
Compatible power cords	Power cord EU, 5 meter	60.30.41.01
	Power cord EU, 2,5 meter	60.30.41.14
	Power cord CH, 5 meter	60.30.41.03
	Power cord CH, 2,5 meter	60.30.41.13
	Power cord UK, 5 meter	60.30.41.02
	Power cord UK, 2.5 meter	60.30.41.15
Compatible interconnect cables	Interconnect cable RJ14, 0,6 meter	60.50.00.08
	Interconnect cable RJ14, 1,5 meter	60.50.00.04
	Interconnect cable RJ14, 2,4 meter	60.50.00.09
	Interconnect cable RJ14, 3 meter	60.50.00.10
Compatible splitter	3 way RJ14 cable splitter	60.50.00.01

3.4. Environment

The product is meant for use in climate rooms. The product may be used in damp environments. The product may not be used in wet environments or outdoors.

3.5. Legal

CE LVD approval according to: EN 60598-1: 2008 + A11: 2009.

CE EMC approval according to: EN 55015 (2006) + A1 (2007) + A2 (2009); EN 61000-3-2 (2006) + A1 (2009) + A2 (2009); EN 61000-3-3 (2008); EN 61547 (2009).

4. Safety recommendations and warnings



Warning! Carefully read the warnings below before using or working with the product!

- Always adhere to the local rules and regulations when installing or using the fixture.
- This product may cause interference to radio equipment and should not be installed near maritime safety communications equipment or other critical navigation or communication equipment operating between 0.45 - 30 MHz.
- Do not use the fixture when its power cord is damaged. Replace the power cord only with original certified cords.
- Modifications to the power cord can lead to unwanted electromagnetic effects, which makes the product not comply with legal requirements.
- Do not expose the fixture to:
 - condensing humidity, heavy mist, fog or direct spray;
 - (ambient) temperatures outside the specified range;
 - dust and contamination;
 - direct sunlight during use or HID light that could heat up the ballast.
- Always disconnect the fixture from the mains before performing any maintenance.

- Always allow for a cool down period of at least 30 minutes before touching the lamp or reflector. Touching reflector when the lamp is lit or immediately afterwards will result in severe burns!
- Do not use the fixture near flammable, explosive or reactive substances. The lamp and the reflector of temperatures of >85 °Celsius.
- Never use the fixture when the glass is broken or without the emitter cover/reflector. There is exposure since the glass serves as an UV filter.
- Do not replace any parts when broken.
- The installation and use of the fixture is the responsibility of the end user. Incorrect use or installation and damage to the fixture. Damage to the fixture and electronic circuitry as a result of incorrect installation revokes the warranty.

5. Contents (1)

- A. Gavita Pro 270° LEP fixture
 1. Electronic ballast
 2. Emitter cover/reflector
 3. Mounting points (2x)
 4. Emitter
 5. Top part of emitter
- B. Threeway control cable splitter (3xRJ14)
- C. 2x Interconnect/ drop cable (RJ14/RJ14)
Cable length: 1,5 m
- D. Local power cord (NEMA 5-15 OR
NEMA 6-15)

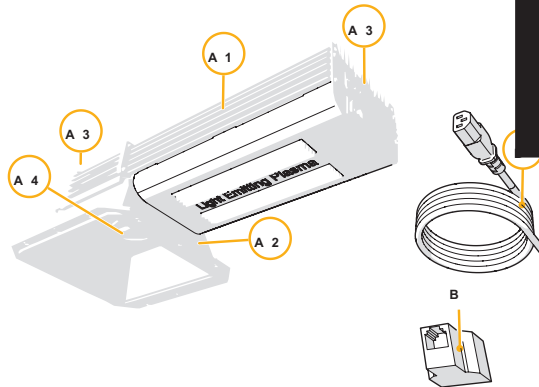

6. Controls, connections and indications (2)

- A. Female RJ14 port for Master controller input
- B. IEC connector for power cord

7. Installing the fixture

- ⚠ **Warning!** Ensure the local cabling can support the voltage and current requirements of the fixture.
- ⚠ **Warning!** Avoid coiled cords and keep mains leads separated. This prevents electromagnetic interference.
- ⚠ **Warning!** When connecting the fixture to the Master controller, the connected lamp may ignite. Make sure either the power is disconnected or the Master controller is switched off.

7.1. Preparing the fixture for use

- Switch off mains power.
- Hang the fixture by its mounting points (3). The mounting points are spaced 507 mm apart.
- ⚠ **Warning!** Make sure the mounting points can hold the weight of the fixture.

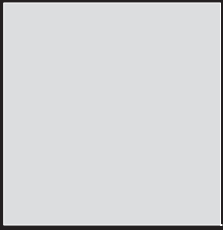

F

